

YASKAWA

LINEAR MOTORS

Linear Sigma-Series



High speed, ease of operation and high reliability

Simplified machine design and construction

A linear motor is directly coupled to the load. Compared to conventional drive/translation mechanisms, this achieves high positioning accuracies and wide operational speed ranges.

Improved machine performance

The linear motion mechanism's stiffness is greatly improved. Multiples of the moving motor parts can be operated independently over a single axis of the magnet track.

Short acceleration and settling time

The linear motors themselves can reach astonishing 20 Gs of maximum acceleration. In combination with the Sigma-7 drive and the performance of the linear motor the after motion settling time will be shortened significantly.

High efficiency

Due to its optimized magnetic circuitry design and high-density windings inherited from the company's legendary Sigma motors, the effects of dissipating heat are minimized.

No magnetic attraction forces

The GW type linear motors have no attraction force between the moving and the stationary parts of the motor and therefore no cogging.

The FW and the new FW2 type motors are Iron-core type and have an attraction force depending on the size of the motor.

No velocity ripple

The linear motor performance levels are further enhanced by the combined use with Sigma-7 digital servodrivers.

High speed

The Linear Sigma Motors can reach speeds as high as 5 meters (196 inches) per second.

Compact force density

The compact design of the YASKAWA motors with their high density winding technology allows a high force output with small motor volumes.

Force linearity

This is achieved through the advanced magnetic circuitry, optimum winding geometry as well as the d-q axis current control method within the powerful Sigma-7 digital servodrivers.

Ease of operation and high reliability

Linear motors are quiet even at high speeds since the only contacting mechanisms in the linear motor system are the linear motion guides.

YASKAWA products stand for high reliability by best performance.



YASKAWA is continuously challenging performance barriers with its linear motor products to improve speed and accuracy. Our linear motors improve performance, reliability, speed and accuracy in most automation applications.

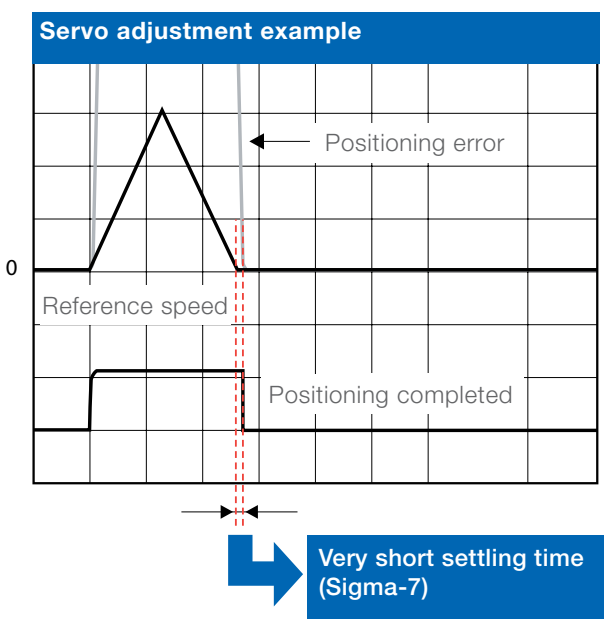

Savings through performance

With a best in class frequency response of 3.1 kHz, Sigma-7 SERVOPACKS can reduce settling time to less than 4 ms. Compared to a standard system with for example 50 ms settling time, a pick & place unit based on Sigma-7 components can save a significant amount of money.

Shorter settling time increases your revenue

Pick & place example with 50 ms settling time

Axis length	Move	Settle	Move	Settle	Time per part	Parts per minute	Parts per hour	Price per part	Revenue per hour
X = 200 mm	0.5 s	0.05 s	0.5 s	0.05 s	1.6 s	37.5	2,250	€ 0.1	225.00 €
X = 200 mm	0.2 s	0.05 s	0.2 s	0.05 s					
Total	0.7 s	0.1 s	0.7 s	0.1 s					

Pick & place example with 4 ms settling time

Axis length	Move	Settle	Move	Settle	Time per part	Parts per minute	Parts per hour	Price per part	Revenue per hour
X = 200 mm	0.5 s	0.004 s	0.5 s	0.004 s	1.416 s	42.37	2,542	€ 0.1	254.24 €
X = 200 mm	0.2 s	0.004 s	0.2 s	0.004 s					
Total	0.7 s	0.008 s	0.7 s	0.008 s					

Revenue per Hour:
29.24 €

Revenue per 16 Hours:
467.84 €

Revenue per 5 Days:
2,339.20 €

Revenue per Year:
116,690.00 €

Combinations

Linear servomotor model		Rated force [N]	Peak force [N]	Single axis SERVOPACK SGD7S-□□□□	Double axis SERVOPACK SGD7W-□□□□	
SGLGW (Coreless model, with standard magnetic way)	200 V	SGLGW-30A050C	12.5	40	R70A	1R6A
		SGLGW-30A080C	25	80		
		SGLGW-40A140C	47	140	R90A	1R6A *1
		SGLGW-40A253C	93	280		1R6A
		SGLGW-40A365C	140	420		2R8A
		SGLGW-60A140C	70	220		1R6A
		SGLGW-60A253C	140	440		2R8A
		SGLGW-60A365C	210	660		5R5A
		SGLGW-90A200C	325	1300	120A	
		SGLGW-90A370C	550	2200	180A	-
SGLGW-90A535C	750	3000	200A			
SGLGW (Coreless model, with high-force magnetic way)	200 V	SGLGW-40A140C	57	230		1R6A
		SGLGW-40A253C	114	460		2R8A
		SGLGW-40A365C	171	690	3R8A	5R5A *1
		SGLGW-60A140C	85	360		1R6A
		SGLGW-60A253C	170	720	3R8A	5R5A *1
		SGLGW-60A365C	255	1080		7R6A
SGLFW2 (Model with F-type iron core)	200 V	SGLFW2-30A070A	45	135		1R6A
		SGLFW2-30A120A	90	270		
		SGLFW2-30A230A	180	540	3R8A	-
			170	500		2R8A
		SGLFW2-45A200A	280	840		5R5A
		SGLFW2-45A380A	560	1680	180A	
		SGLFW2-90A200A	560	1500	120A	
		SGLFW2-90A380A	1120	3360	200A	
		SGLFW2-90A560A	1680	5040	330A	-
		SGLFW2-1DA380A	1680	5040	200A	
	SGLFW2-1DA560A	2520	7560	330A		
	400 V	SGLFW2-30D070A	45	135		
		SGLFW2-30D120A	90	270		1R9D
		SGLFW2-30D230A	180	540		
		SGLFW2-45D200A	280	840		3R5D
		SGLFW2-45D380A	560	1680		8R4D
				1500		5R4D
		SGLFW2-90D200A	560	1680		5R4D
		SGLFW2-90D380A	1120	3360		120D
		SGLFW2-90D560A	1680	5040		
SGLFW2-1DD380A		1680	5040		170D *2	
SGLFW2-1DD560A	2520	7560	260D *2	-		
SGLFW (Model with F-type iron core)	200 V	SGLFW-20A090A	25	86		
		SGLFW-20A120A	40	125		1R6A
		SGLFW-35A120A	80	220		
		SGLFW-35A230A	160	440	3R8A	5R5A
		SGLFW-50A200B	280	600		5R5A
		SGLFW-50A380B	560	1200	120A	
		SGLFW-1ZA200B			200A	-
	400 V	SGLFW-1ZA380B	1120	2400		
		SGLFW-35D120A	80	220		1R9D
		SGLFW-35D230A	160	440		
		SGLFW-50D200B	280	600		3R5D
		SGLFW-50D380B	560	1200		
		SGLFW-1ZD200B	560	1200		5R4D
		SGLFW-1ZD380B	1120	2400	120D	-
SGLFW-1ED380B	1500	3600	8R4D	-		
SGLFW-1ED560B	2250	5400	120D	-		

*1 If you use the double axis SERVOPACK please be aware of the reduced efficiency (derating) in case of a simultaneously high load usage of both of the motors.

*2 Contact your YASKAWA representative for information on these SERVOPACK models.

Model designations

Moving Coil

S G L F W - 20 D 090 A P □

Sigma-7 Series
Linear Servomotors

1st 2nd

3rd + 4th 5th 6th - 8th 9th 10th 11th digit

1st digit - Specification

Code	Servomotor Type
F	With F-type iron core

2nd digit - Moving Coil/Magnetic Way

Code	Specification
W	Moving coil

3rd + 4th digit - Magnet Height

Code	Specification
20	20 mm
35	36 mm
50	47.5 mm
1Z	95 mm

5th digit - Voltage

Code	Specification
A	200 VAC

6th - 8th digit - Length of Moving Coil

Code	Specification
090	91 mm
120	127 mm
200	215 mm
230	235 mm
380	395 mm

9th digit - Design Revision Order

Code	Specification
A, B...	

10th digit - Sensor Specification

Code	Specification
P	With polarity sensor
None	Without polarity sensor

11th digit - Connector for Servomotor Main Circuit Cable

Code	Specification	Applicable Models
None	Connector from Tyco Electronics Japan G.K.	All models
D	Connector from Interconnectron GmbH	SGLFW-35, -50, -1Z□200B

Magnetic Way

S G L F M - 20 324 A □

Sigma-7 Series
Linear Servomotors

1st 2nd

3rd + 4th 5th - 7th 8th 9th digit

1st digit - Servomotor Type

Code	Specification
F	With F-type iron core

2nd digit - Moving Coil/Magnetic Way

Code	Specification
M	Magnetic way

3rd + 4th digit - Magnet Height

Code	Specification
20	20 mm
35	36 mm
50	47.5 mm
1Z	95 mm

5rd ... 7th digit - Length of Magnetic Way

Code	Specification
324	324 mm
405	405 mm
540	540 mm
675	675 mm
756	756 mm
945	945 mm

8th digit - Design Revision Order

Code	Specification
A, B...	

9th digit - Options

Code	Specification
None	Without options
C	With magnet cover

Note:

This information is provided to explain model numbers. It is not meant to imply that models are available for all combinations of codes.

Model designations

Moving Coil

S G L F W2 - 30 D 070 A S 1 E

Sigma-7 Series
1st
2nd
3rd + 4th
5th
6th - 8th
9th
10th
11th
12th
digit

Linear Servomotors:

1st digit - Servomotor Type	
Code	Specification
F	With F-type iron core

2nd digit - Moving Coil/Magnetic Way	
Code	Specification
W2	Moving coil

3rd + 4th digit - Magnet Height	
Code	Specification
30	30 mm
45	45 mm
90	90 mm
1D	135 mm

5th digit - Power Supply Voltage	
Code	Specification
A	200 VAC
D	400 VAC

6th ... 8th digit - Length of Moving Coil	
Code	Specification
070	70 mm
120	125 mm
200	205 mm
230	230 mm
380	384 mm

9th digit - Design Revision Order	
Code	Specification
A	Standard model

10th digit - Sensor Specification	
Code	Specification
T	Without polarity sensor, with thermal protector
S	With polarity sensor and thermal protector

11th digit - Options	
Code	Cooling Method
1	Self-cooled
L	Water-cooled*

12th digit - Options	
Code	Connection
E	Metal round connector (Phoenix)

* Contact your YASKAWA representative for information on water-cooled model.

Magnetic Way

S G L F M2 - 30 270 A

Sigma-7 Series
1st
2nd
3rd + 4th
5th - 7th
8th
digit

Linear Servomotors:

1st digit - Servomotor Type	
Code	Specification
F	With F-type iron core

2nd digit - Moving Coil/Magnetic Way	
Code	Specification
M2	Magnetic way

3rd + 4th digit - Magnet Height	
Code	Specification
30	30 mm
45	45 mm
90	90 mm
1D	135 mm

5th ... 7th digit - Length of Magnetic Way	
Code	Specification
270	270 mm
306	306 mm
450	450 mm
510	510 mm
630	630 mm
714	714 mm

8th digit - Design Revision Order	
Code	Specification
A	Standard model with covered magnets

Note: This information is provided to explain model numbers. It is not meant to imply that models are available for all combinations of codes.

Moving Coil

SGL G W - 30 A 050 C P □

Sigma-7 Series Linear Servomotors
 1st 2nd 3rd + 4th 5th 6th - 8th 9th 10th 11th digit

1st digit - Servomotor Type

Code	Specifications
G	Coreless model

2nd digit - Moving Coil/Magnetic Way

Code	Specification
W	Moving coil

3rd + 4th digit - Magnet Height

Code	Specification
30	30 mm
40	40 mm
60	60 mm
90	86 mm

5th digit - Power Supply Voltage

Code	Specification
A	200 VAC

6th ... 8th digit - Length of Moving Coil

Code	Specification
050	50 mm
080	80 mm
140	140 mm
200	199 mm
253	252.5 mm
365	365 mm
370	367 mm
535	535 mm

9th digit - Design Revision Order

Code	Specification
A, B...	

10th digit - Sensor Specification and Cooling Method

Code	Specifications		Applicable Models
	Polarity Sensor	Cooling Method	
None	None	Self-cooled	All models
C	None	Air-cooled	SGLGW-40A, -60A, -90A
H	Yes	Air-cooled	
P	Yes	Self-cooled	All models

11th digit - Connector for Servomotor Main Circuit Cable

Code	Specifications	Applicable Models
None	Connector from Tyco Electronics Japan G.K.	All models
P	Connector from Interconnectron GmbH	SGLGW-30A, -40A, -60A

Magnetic Way

SGL G M - 30 050 C □

Sigma-7 Series Linear Servomotors
 1st 2nd 3rd + 4th 5th - 7th 8th 9th digit

1st digit - Servomotor Type

Code	Specifications
G	Coreless model

2nd digit - Moving Coil & Magnetic Way

Code	Specifications
M	Magnetic way

3rd + 4th digit - Magnet Height

Code	Specifications
30	30 mm
40	40 mm
60	60 mm
90	86 mm

5rd ... 7th digit - Length of Magnetic Way

Code	Specifications
090	90 mm
108	108 mm
216	216 mm
225	225 mm
252	252 mm
360	360 mm
405	405 mm
432	432 mm
450	450 mm
504	504 mm

8th digit - Design Revision Order

Code	Specifications
A, B, C*	

9th digit - Options

Code	Specifications	Applicable Models
None	Standard-force	All models
-M	High-force	SGLGM-40, -60

*: SGLGM-40 and SGLGM-60 also have a CT Code.
 C = Without mounting holes on the bottom.
 CT = With mounting holes on the bottom.

Coreless SGLGW/SGLGM specifications

Operating environment	
Time rating	Continuous
Thermal class	B
Ambient temperature	0 to +40 °C (without freezing)
Ambient humidity	20 to 80% (non-condensing)
Insulation resistance	10 MΩ min., 500 VDC
Excitation	Permanent magnet
Withstand voltage	1,500 VAC for 1 minute
Protection methods	Self-cooled or air-cooled

200 V class, with standard-force magnetic way

Linear motor model SGLGW-	30A			40A			60A			90A			
	050C	080C	140C	253C	365C	140C	253C	365C	200C	370C	535C		
Rated force*1, *2	N	12.5	25	47	93	140	70	140	210	325	550	750	
Rated current*1	Arms	0.51	0.79	0.8	1.6	2.4	1.2	2.2	3.3	4.4	7.5	10.2	
Instantaneous peak force*1	N	40	80	140	280	420	220	440	660	1300	2200	3000	
Instantaneous peak current*1	Arms	1.6	2.5	2.4	4.9	7.3	3.5	7.0	10.5	17.6	30.0	40.8	
Coil assembly weight	kg	0.1	0.15	0.34	0.60	0.87	0.42	0.76	1.1	2.2	3.6	4.9	
Force constant	N / Arms	26.4	33.9	61.5	61.5	61.5	66.6	66.6	66.6	78	78	78	
BEMF constant	Vrms / (m/s) / phase	8.8	11.3	20.5	20.5	20.5	22.2	22.2	22.2	26.0	26.0	26.0	
Motor constant	N/√W	3.66	5.63	7.79	11.0	13.5	11.1	15.7	19.2	26.0	36.8	45.0	
Electrical time constant	ms	0.19	0.41	0.43	0.43	0.43	0.45	0.45	0.45	1.4	1.4	1.4	
Mechanical time constant	ms	7.5	4.7	5.6	5	4.8	3.4	3.1	3	3.3	2.7	2.4	
Thermal resistance (with heat sink)	K / W	5.19	3.11	1.67	0.87	0.58	1.56	0.77	0.51	0.39	0.26	0.22	
Thermal resistance (without heat sink)	K / W	8.13	6.32	3.02	1.80	1.23	2.59	1.48	1.15	1.09	0.63	0.47	
Magnetic attraction	N	0	0	0	0	0	0	0	0	0	0	0	
Combined Magnetic Way, SGLGM-		30□□□□			40□□□□			60□□□□			90□□□□		
Combined Serial Converter Unit, JZDP-□□□□-		250	251	252	253	254	258	259	260	264	265	266	
Applicable SERVOPACKs	SGD7S- SGD7W-	R70A 1R6A	R90A 1R6A	R90A 1R6A	1R6A 1R6A	2R8A 2R8A	1R6A 1R6A	2R8A 2R8A	5R5A 5R5A	120A -	180A -	200A -	

200 V class, with high-force magnetic may

Linear motor model SGLGW-	40A			60A			
	140C	253C	365C	140C	253C	365C	
Rated force*1, *2	N	57	114	171	85	170	255
Rated current*1	Arms	0.8	1.6	2.4	1.2	2.2	3.3
Instantaneous peak force*1	N	230	460	690	360	720	1080
Instantaneous peak current*1	Arms	3.2	6.5	9.7	5.0	10.0	14.9
Coil assembly weight	kg	0.34	0.6	0.87	0.42	0.76	1.1
Force constant	N / Arms	76.0	76.0	76.0	77.4	77.4	77.4
BEMF constant	Vrms / (m/s) / phase	25.3	25.3	25.3	25.8	25.8	25.8
Motor constant	N/√W	9.62	13.6	16.7	12.9	18.2	22.3
Electrical time constant	ms	0.43	0.43	0.43	0.45	0.45	0.45
Mechanical time constant	ms	3.7	3.2	3.1	2.5	2.3	2.2
Thermal resistance (with heat sink)	K / W	1.67	0.87	0.58	1.56	0.77	0.51
Thermal resistance (without heat sink)	K / W	3.02	1.80	1.23	2.59	1.48	1.15
Magnetic attraction	N	0	0	0	0	0	0
Combined Magnetic Way, SGLGM-		40□□□□-M			60□□□□-M		
Combined Serial Converter Unit, JZDP-□□□□-		255	256	257	261	262	263
Applicable SERVOPACKs	SGD7S- SGD7W-	1R6A 1R6A	2R8A 2R8A	3R8A 5R5A	1R6A 1R6A	3R8A 5R5A	7R6A 7R6A

*1. These values are for operation in combination with a SERVOPACK when the temperature of the armature winding is 100 °C. The values for other items are at 20 °C. These are typical values.

*2. The rated forces are the continuous allowable force values at a ambient air temperature of 40 °C with an aluminum heat sink of the dimensions given in the following table.

• Heat Sink Dimensions

- 200 mm × 300 mm × 12 mm: SGLGW-30A050C, -30A080C, -40A140C, and -60A140C
- 400 mm × 500 mm × 12 mm: SGLGW-40A365C and -60A365C

- 300 mm × 400 mm × 12 mm: SGLGW-40A253C and -60A253C
- 800 mm × 900 mm × 12 mm: SGLGW-90A200C, -90A370C, and -90A535C



Force-speed characteristics

A : Continuous duty zone — (solid lines): With three-phase 200 V input
B : Intermittent duty zone - - - (dotted lines): With single-phase 100 V input

With standard-force magnetic way

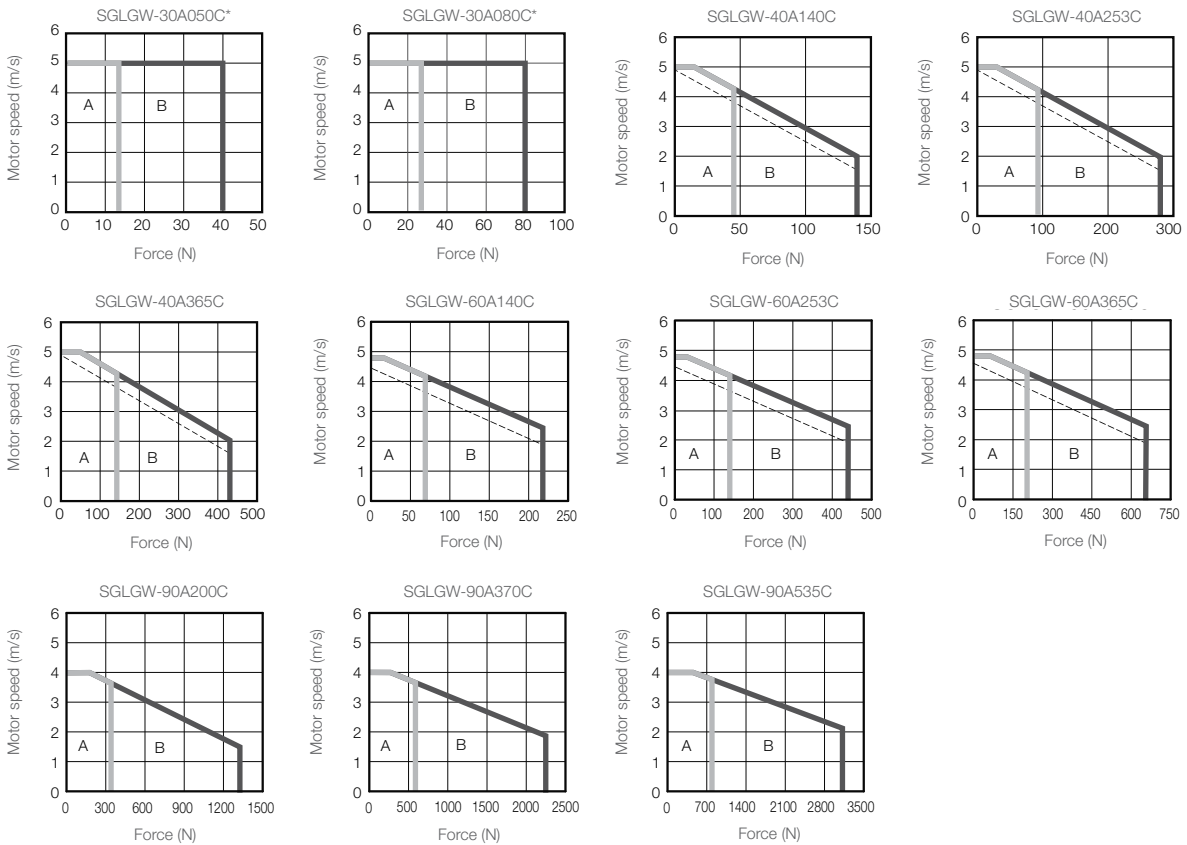

With high-force magnetic way

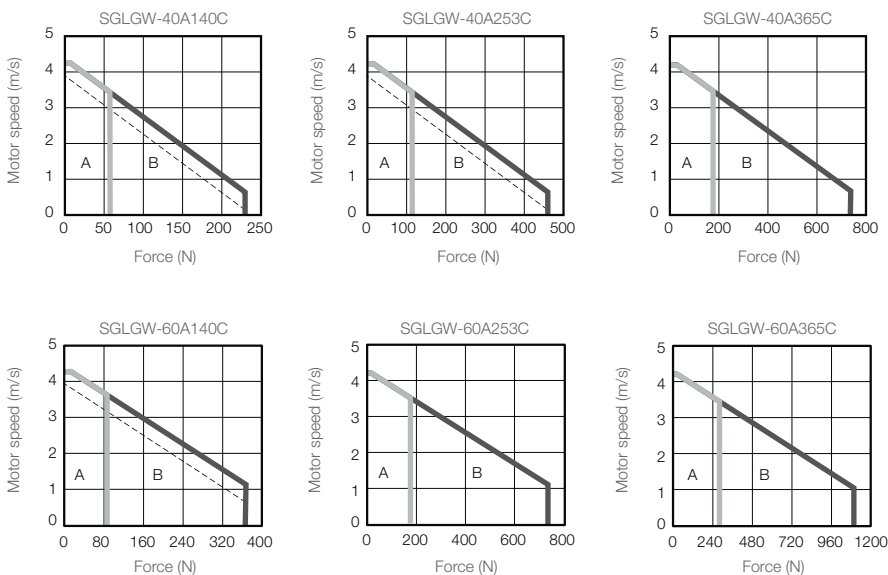

Dimensions for core-less SGLGW/SGLGM models

Coil assembly: SGLGW-□□A□□□□□□

Coil assembly model SGLGW	Figure	L1	L2	L3	L4	L5	L6	N1	N2	W	G (Gap)	Weight* [kg]	
30A050C □ D	1	50	48	30	20	20	-	-	-	5.9	0.85	0.14	
30A080C □ D		80	72	50	30	25	-	-	-	5.7	0.95	0.19	
40A140C □ D	2	140	125	90	30	52.5	45	3	4	-	0.80	0.40	
40A253C □ D		252.5	237.5	180		37.5	60	135	5			8	0.66
40A365C □ D		365	350	315	30	52.5	270	8	14			0.93	
60A140C □ D		140	125	90	40	45	45	3	4			0.48	
60A253C □ D		252.5	237.5	180		37.5	60	135	5			8	0.82
60A365C □ D		365	350	315		30	52.5	270	8			14	1.16
90A200C □ D	199	189	130	60		95	3	4	2.2				
90A370C □ D	367	357	260	55	285	5	8	3.65					
90A535C □ D	535	525	455	60	380	8	10	4.95					

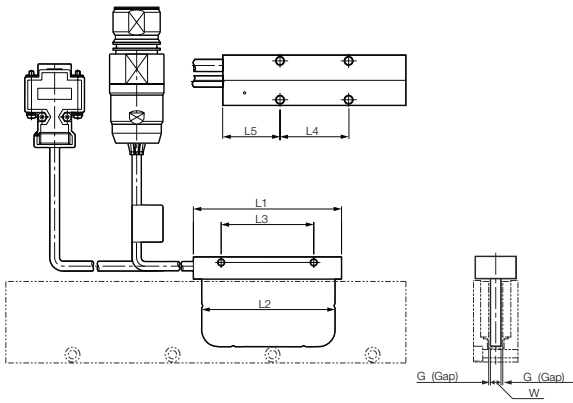

Figure 1

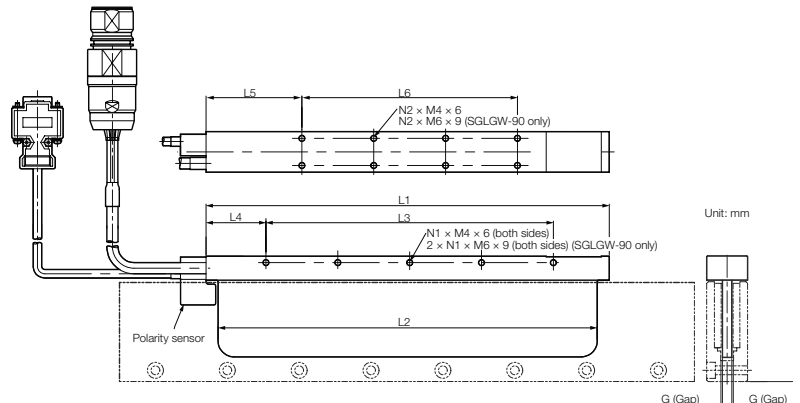

Figure 2

Magnetic way: SGLGM-□□□□□□□□

Magnetic way model SGLGM	Force	Figure	L1 mm	L2 mm	N	Weight* [kg]
30108A	Standard Force	3	108	54	2	0.6
30216A			216	162	4	1.1
30432A			432	378	8	2.3
40090C or 40090CT		90	45	2	0.8	
40225C or 40225CT		225	180	5	2.0	
40360C or 40360CT		360	315	8	3.1	
40405C or 40405CT		405	360	9	3.5	
40450C or 40450CT		450	405	10	3.9	
40090C-M or 40090CT-M		90	45	2	1.0	
40225C-M or 40225CT-M		225	180	5	2.6	
40360C-M or 40360CT-M	360	315	8	4.1		
40405C-M or 40405CT-M	405	360	9	4.6		
40450C-M or 40450CT-M	450	405	10	5.1		
60090C or 60090CT	High Force	4	90	45	2	1.1
60225C or 60225CT			225	180	5	2.6
60360C or 60360CT			360	315	8	4.1
60405C or 60405CT		405	360	9	4.6	
60450C or 60450CT		450	405	10	5.1	
60090C-M or 60090CT-M		90	45	2	1.3	
60225C-M or 60225CT-M		225	180	5	3.3	
60360C-M or 60360CT-M		360	315	8	5.2	
60405C-M or 60405CT-M		405	360	9	5.9	
60450C-M or 60450CT-M		450	405	10	6.6	
90252A	Standard Force	4	252	189	4	7.3
90504A			504	441	8	14.7

* The values indicate the mass of a moving coil with a polarity sensor.

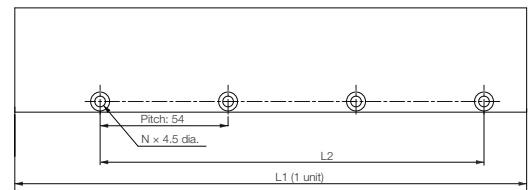

Figure 3

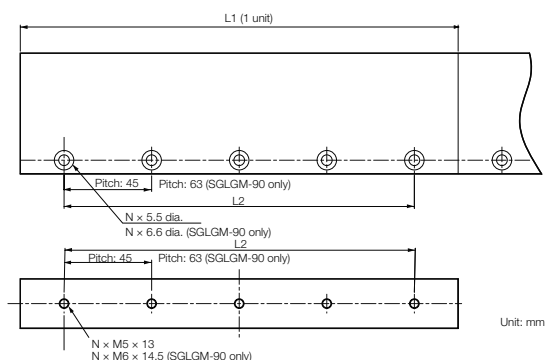
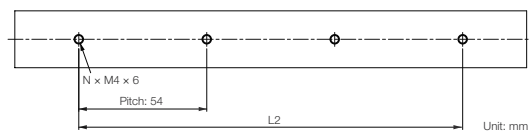

Figure 4

Iron-core SGLFW2/SGLFM2 specifications

Operating environment	
Time rating	Continuous
Thermal class	B
Ambient temperature	0 to +40 °C (without freezing)
Ambient humidity	20 to 80% (non-condensing)
Insulation resistance	10 MΩ min., 500 VDC
Excitation	Permanent magnet
Withstand voltage	1,500 VAC for 1 minute (230 V models) 1,800 VAC for 1 minute (400 V models)
Protection methods	Self-cooled or water-cooled*

* Contact your YASKAWA representative for information on water-cooled models.

200 V Models

Linear motor model SGLFW2-		30A				45A		90A			1DA	
		070A	120A	230A		200A	380A	200A	380A	560A	380A	560A
Rated force*1, *2	N	45	90	180	170	280	560	560	1120	1680	1680	2520
Rated current*1	Arms	1.4	1.5	2.9	2.8	4.4	8.7	7.2	14.4	21.6	14.4	21.6
Instantaneous peak force*1	N	135	270	540	500	840	1680	1500	1680	3360	5040	7560
Instantaneous peak current*1	Arms	5.3	5.2	10.5	9.3	16.4	32.7	27.5	26.9	53.9	80.8	53.9
Coil assembly weight	kg	0.5	0.9	1.7		2.9	5.5	5.3	10.1	14.9	14.6	21.5
Force constant	N / Arms	33.3	64.5	64.5		67.5	67.5	82.0	82.0	82.0	123	123
BEMF constant	Vrms / (m/s) / phase	11.1	21.5	21.5		22.5	22.5	27.3	27.3	27.3	41.0	41.0
Motor constant	N/√W	11.3	17.3	24.4		36.9	52.2	58.1	82.2	101	105	129
Electrical time constant	ms	7.6	7.3	7.3		19	19	24	23	24	25	25
Mechanical time constant	ms	3.9	3.0	2.9		2.1	2.0	1.6	1.5	1.5	1.3	1.3
Thermal resistance (with heat sink)	K / W	2.62	1.17	0.79		0.60	0.44	0.45	0.21	0.18	0.18	0.12
Thermal resistance (without heat sink)	K / W	11.3	4.43	2.55		2.64	1.49	1.81	1.03	0.72	0.79	0.55
Magnetic attraction	N	200	630	1260		2120	4240	4240	8480	12700	12700	19100
Combined Magnetic Way, SGLFM2-		30□□□A				45□□□A		90□□□A			1D□□□A	
Combined Serial Converter Unit, JZDP-□□□□-		628	629	630		631	632	633	634	648	649	650
Applicable SERVOPACKs	SGD7S-	1R6A	1R6A	3R8A	2R8A	5R5A	180A	120A	120A	200A	330A	200A
	SGD7W-	1R6A	1R6A	-	2R8A	5R5A	-	-	-	-	-	-

400 V Models

Linear motor model SGLFW2-		30D			45D		90D			1DA	
		070A	120A	230A	200A	380A	200A	380A	560A	380A	560A
Rated force*1, *2	N	45	90	180	280	560	560	1120	1680	1680	2520
Rated current*1	Arms	1.4	1.5	1.5	2.2	4.3	3.8	7.7	11.5	10.9	16.3
Instantaneous peak force*1	N	135	270	540	840	1680	1500	1680	3360	5040	7560
Instantaneous peak current*1	Arms	5.3	5.2	5.1	8.1	16.2	13.6	14	28	42	39.7
Coil assembly weight	kg	0.5	0.9	1.7	2.9	5.4		5.3	10.1	14.9	14.6
Force constant	N / Arms	33.3	64.5	129	137	136.7		154	154	154	163
BEMF constant	Vrms / (m/s) / phase	11.1	21.5	43	45.6	45.6		51.3	51.3	51.3	54.3
Motor constant	N/√W	11.3	17.3	24.4	37.6	53.2		59.2	83.7	102	103
Electrical time constant	ms	7.6	7.3	7.3	20	19.6		24	24	24	25
Mechanical time constant	ms	3.9	3.0	2.9	2.1	1.9		1.5	1.4	1.4	1.4
Thermal resistance (with heat sink)	K / W	2.62	1.17	0.79	0.6	0.44		0.45	0.21	0.18	0.18
Thermal resistance (without heat sink)	K / W	11.3	4.43	2.55	2.64	1.49		1.81	1.03	0.72	0.79
Magnetic attraction	N	200	630	1260	2120	4240		4240	8480	12700	12700
Combined Magnetic Way, SGLFM2-		30□□□A			45□□□A		90□□□A			1D□□□A	
Combined Serial Converter Unit, JZDP-□□□□-		651	652	653	654	655		657	658	659	660
Applicable SERVOPACKs	SGD7S-	1R9D	1R9D	1R9D	3R5D	8R4D	5R4D	5R4D	120D	170D*3	170D*3
	SGD7W-	1R9D	1R9D	1R9D	3R5D	8R4D	5R4D	5R4D	120D	170D*3	170D*3

*1. These values are for operation in combination with a SERVOPACK when the temperature of the armature winding is 100 °C. The values for other items are at 20 °C. These are typical values.

*2. The rated forces are the continuous allowable force values at a ambient air temperature of 40 °C with an aluminum heat sink of the dimensions given in the following table.

• Heat Sink Dimensions

- 150 mm × 100 mm × 10 mm: SGLFW2-30o070A
- 400 mm × 500 mm × 10 mm: SGLFW2-45A200A, -45A380A, -90A200A
- 609 mm × 762 mm × 10 mm: SGLFW2-90A380A
- 900 mm × 762 mm × 10 mm: SGLFW2-90A560A and -1DA380A
- 1200 mm × 762 mm × 10 mm: SGLFW2-1DA560A
- 254 mm × 254 mm × 25 mm: SGLFW2-30o120A and -30o230A
- 400 mm × 500 mm × 40 mm: SGLFW2-45D200A, -45D380A and -90D200A
- 609 mm × 762 mm × 40 mm: SGLFW2-90D380A
- 900 mm × 762 mm × 40 mm: SGLFW2-90D560A and -1DD380A
- 1400 mm × 900 mm × 40 mm: SGLFW2-1DD560A

*3. Contact your YASKAWA representative for information on these servopack models.

Force-speed characteristics

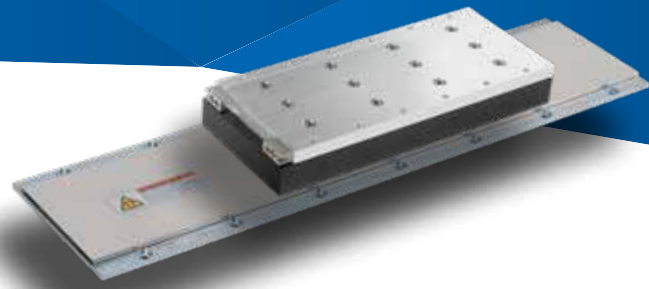

200 V models

A : Continuous duty zone ——— With three-phase 230-V input
B : Intermittent duty zone - - - - - With single-phase 230-V input

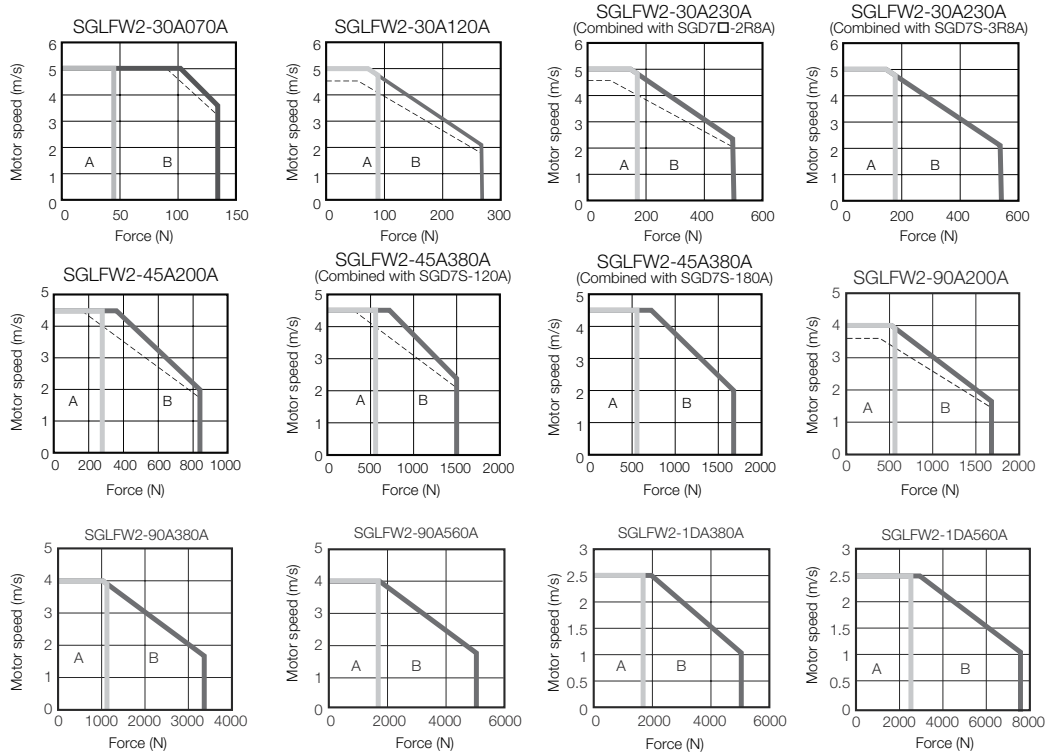

400 V models

A : Continuous duty zone ——— With three-phase 400-V input
B : Intermittent duty zone

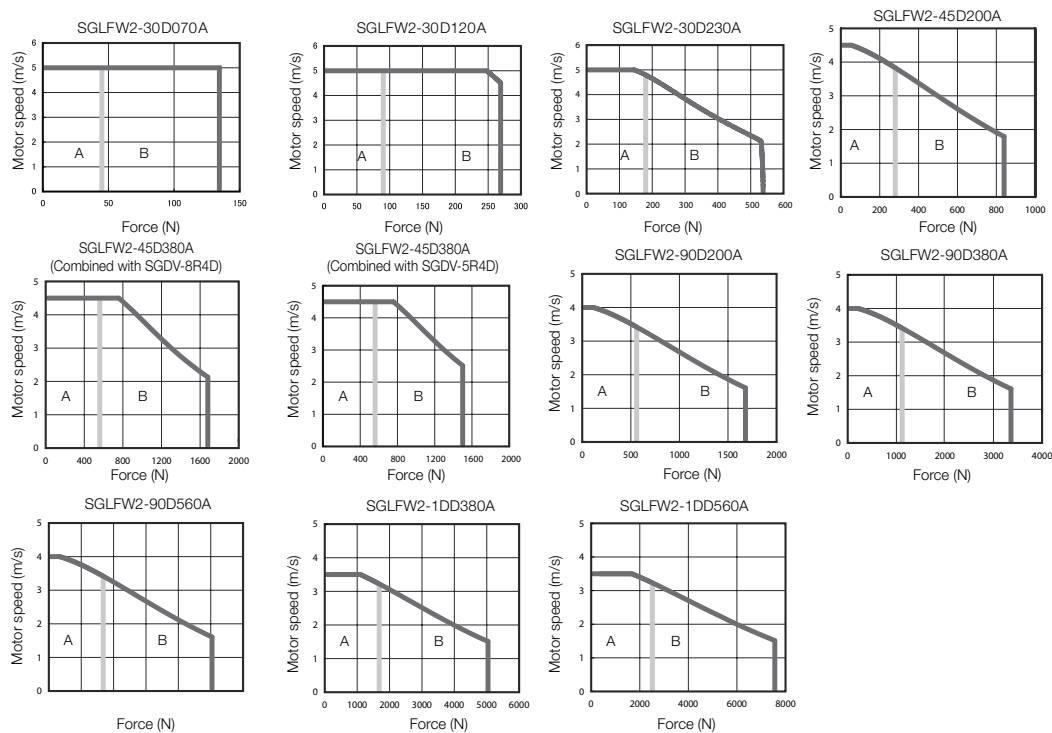

Dimensions for iron-core SGLFW2/SGLFM2 models

Coil assembly: SGLGW2-□□□□□□A□□

Coil assembly model SGLFW2-	Width [mm]	Height [mm]	Length [mm]			Weight* [kg]	
	incl. magnetic way, W	incl. magnetic way, H	moving coil, L1	polarity sensor, A	total, L		
30A070A□	55	40	70	27	97	0.5	
30D070A□							0.6
30A120A□			125		152	0.9	
30D120A□						1.0	
30A230A□			230		257	1.7	
30D230A□				1.8			
45□200A□	75	50	205	32	237	2.9	
45□380A□			384		416	5.5	
90□200A□			205		237	5.3	
90□380A□	120	50	384	32	416	10.1	
90□560A□			563		595	14.9	
1D□380A□			384		416	14.6	
1D□560A□	175	50	563	32	595	21.5	

* The values indicate the mass of a moving coil with a polarity sensor.

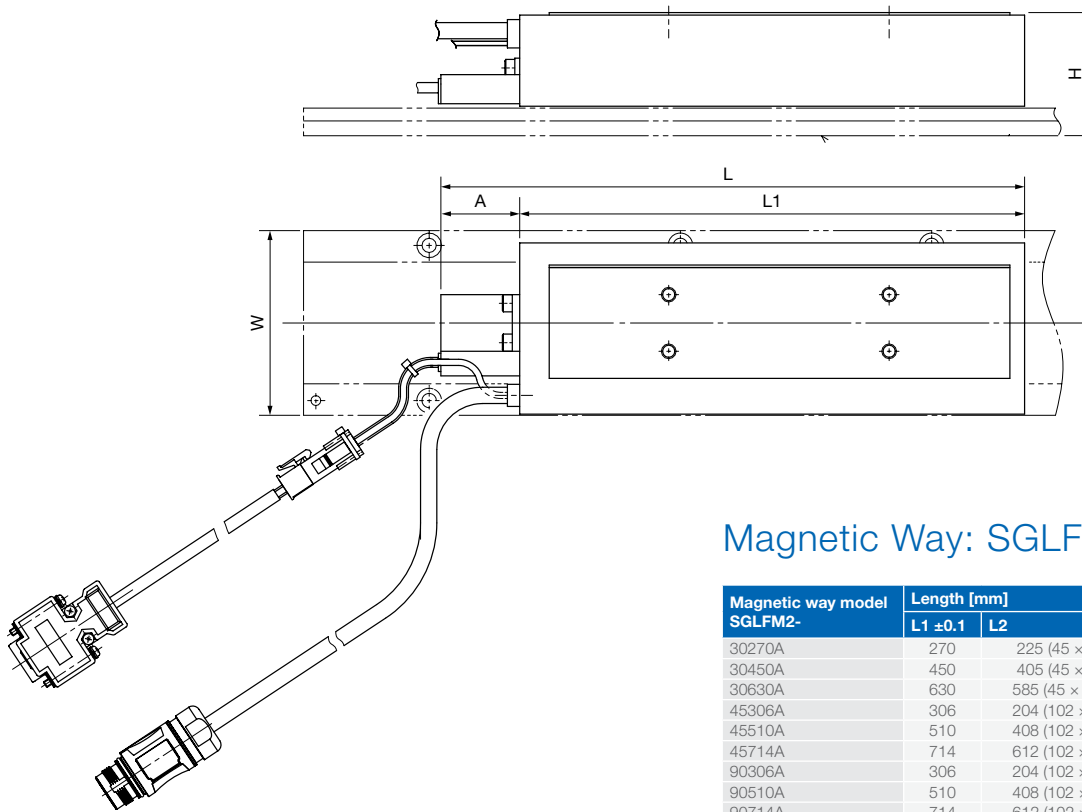

Magnetic Way: SGLFM2-□□□□□□A

Magnetic way model SGLFM2-	Length [mm]		Weight [kg]
	L1 ±0.1	L2	
30270A	270	225 (45 × 5)	0.9
30450A	450	405 (45 × 9)	1.5
30630A	630	585 (45 × 13)	2
45306A	306	204 (102 × 2)	1.5
45510A	510	408 (102 × 4)	2.5
45714A	714	612 (102 × 6)	3.4
90306A	306	204 (102 × 2)	2.6
90510A	510	408 (102 × 4)	4.2
90714A	714	612 (102 × 6)	5.9
1D306A	360	204 (102 × 2)	3.7
1D510A	510	408 (102 × 4)	6.2
1D714A	714	612 (102 × 6)	8.6

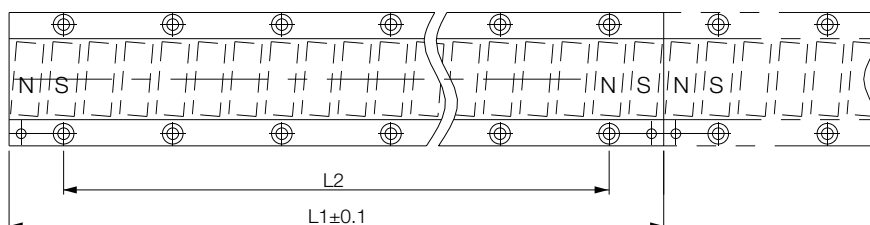

Iron-Core SGLFW/SGLFM specifications

Operating environment	
Time rating	Continuous
Thermal class	B
Ambient temperature	0 to +40 °C (without freezing)
Ambient humidity	20 to 80% (non-condensing)
Insulation resistance	10 MΩ min., 500 VDC
Excitation	Permanent magnet
Withstand voltage	1,500 VAC for 1 minute
Protection methods	Self-cooled

200 V Models

Linear motor model SGLFW-	20A		35A		50A		12A	
	090A	120A	120A	230A	200B	380B	200B	380B
Rated force*1, *2	N	25 40	80	160	280	560	560	1120
Rated current*1	Arms	0.7 0.8	1.4	2.8	5	10	8.7	17.5
Instantaneous peak force*1	N	86 125	220	440	600	1200	1200	2400
Instantaneous peak current*1	Arms	3.0 2.9	4.4	8.8	12.4	25	21.6	43.6
Coil assembly weight	kg	0.7 0.9	1.3	2.3	3.5	6.9	6.4	12
Force constant	N / Arms	36 54	62.4	62.4	60.2	60.2	69	69
BEMF constant	Vrms / (m/s) /phase	12 18	20.8	20.8	20.1	20.1	23	23
Motor constant	N/√W	7.95 9.81	14.4	20.4	34.3	48.5	52.4	74
Electrical time constant	ms	3.2 3.3	3.6	3.6	16	16	18	18
Mechanical time constant	ms	11 9.4	6.3	5.5	3.0	2.9	2.3	2.1
Thermal resistance (with heat sink)	K / W	4.35 3.19	1.57	0.96	0.56	0.38	0.47	0.2
Thermal resistance (without heat sink)	K / W	7.69 5.02	4.1	1.94	1.65	0.95	1.3	0.73
Magnetic attraction	N	310 460	810	1590	1650	3260	3300	6520
Combined Magnetic Way, SGLFM-		20□□□A	35□□□A	50□□□A	12□□□A			
Combined Serial Converter Unit, JZDP-□□□□-		017 018	019 020	181	182	183	184	
Applicable SERVOPACKs	SGD7S-	1R6A 1R6A	1R6A 3R8A	5R5A	120A	120A	200A	
	SGD7W-	1R6A 1R6A	1R6A 5R5A	5R5A	-	-	-	

400 V Models

Linear motor model SGLFW-	35D		50D		12D		1ED	
	120A	230A	200B	380B	200B	380B	380B	560B
Rated force*1, *2	N	80 160	280	560	560	1120	1500	2250
Rated current*1	Arms	0.6 1.3	2.3	4.5	4.9	9.8	6.4	9.6
Instantaneous peak force*1	N	220 440	600	1200	1200	2400	3600	5400
Instantaneous peak current*1	Arms	2.0 4.0	5.6	11.0	12.3	24.6	18.1	27.2
Coil assembly weight	kg	1.3 2.3	3.5	6.9	6.4	11.5	20	29
Force constant	N / Arms	136.0 136.0	134.7	134.7	122.6	122.6	250	250
BEMF constant	Vrms / (m/s) /phase	45.3 45.3	44.9	44.9	40.9	40.9	83.2	83.2
Motor constant	N/√W	14.2 20.1	33.4	47.2	51.0	72.1	95.4	117
Electrical time constant	ms	3.7 3.6	15.0	15.0	17.4	17.2	16.9	16.9
Mechanical time constant	ms	5.2 5.1	3.2	3.2	2.5	2.2	2.2	2.1
Thermal resistance (with heat sink)	K / W	1.57 0.96	0.56	0.38	0.47	0.2	0.19	0.15
Thermal resistance (without heat sink)	K / W	4.1 1.94	1.65	0.95	1.3	0.73	0.45	0.37
Magnetic attraction	N	810 1590	1650	3260	3300	6520	9780	14600
Combined Magnetic Way, SGLFM-		35□□□A	50□□□A	12□□□A	1E135A			
Combined Serial Converter Unit, JZDP-□□□□-		211 212	189 190	191	192	333	334	
Applicable SERVOPACKs	SGD7S-	1R9D 1R9D	3R5D 5R4D	5R4D	120D	8R4D	120D	
	SGD7W-	1R9D 1R9D	3R5D 5R4D	5R4D	-	-	-	

*1. These values are for operation in combination with a SERVOPACK when the temperature of the armature winding is 100 °C. The values for other items are at 20 °C. These are typical values.

*2. The rated forces are the continuous allowable force values at a ambient air temperature of 40 °C with an aluminum heat sink of the dimensions given in the following table.

• Heat Sink Dimensions

- 125 mm × 125 mm × 13 mm: SGLFW-20A090A and -20A120A
- 254 mm × 254 mm × 25 mm: SGLFW-35□120A and -35□230A
- 400 mm × 500 mm × 40 mm: SGLFW-50□200B, -50□380B and -12□200B
- 609 mm × 762 mm × 50 mm: SGLFW-12□380B
- 609 mm × 762 mm × 50 mm: SGLFW-1ED380B, SGLFW-1ED560B

Force-speed characteristics

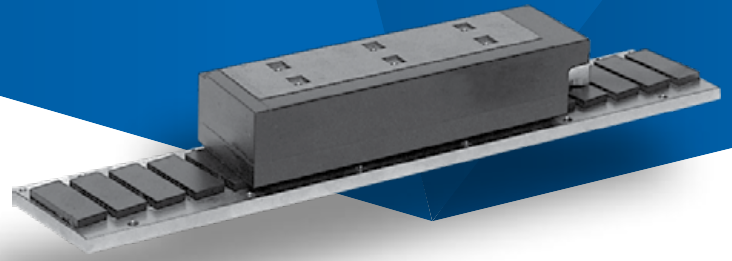

200 V models

A : Continuous duty zone ——— (solid lines): With three-phase 200-V input
B : Intermittent duty zone - - - - - (dotted lines): With single-phase 100-V input

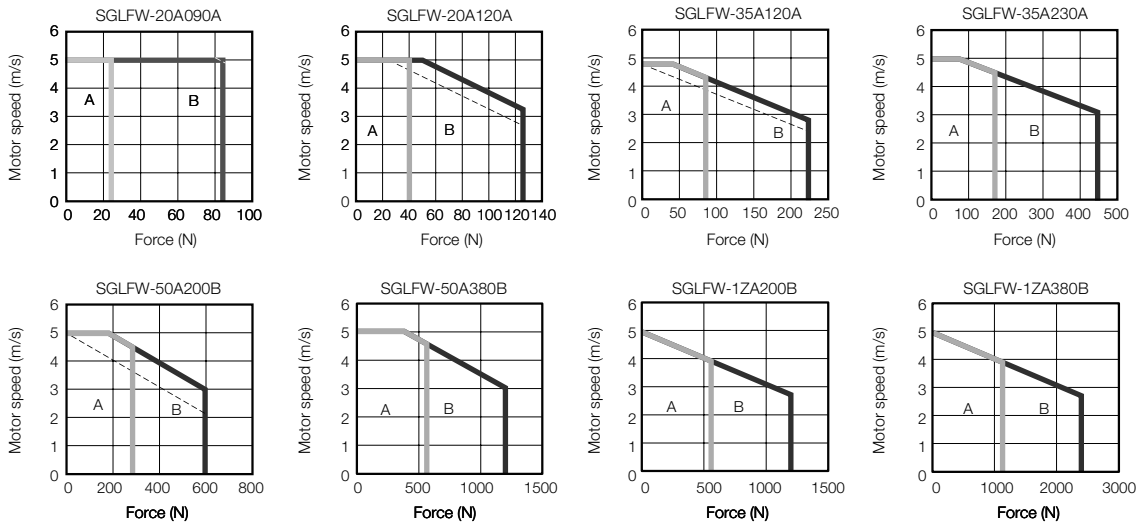

400 V models

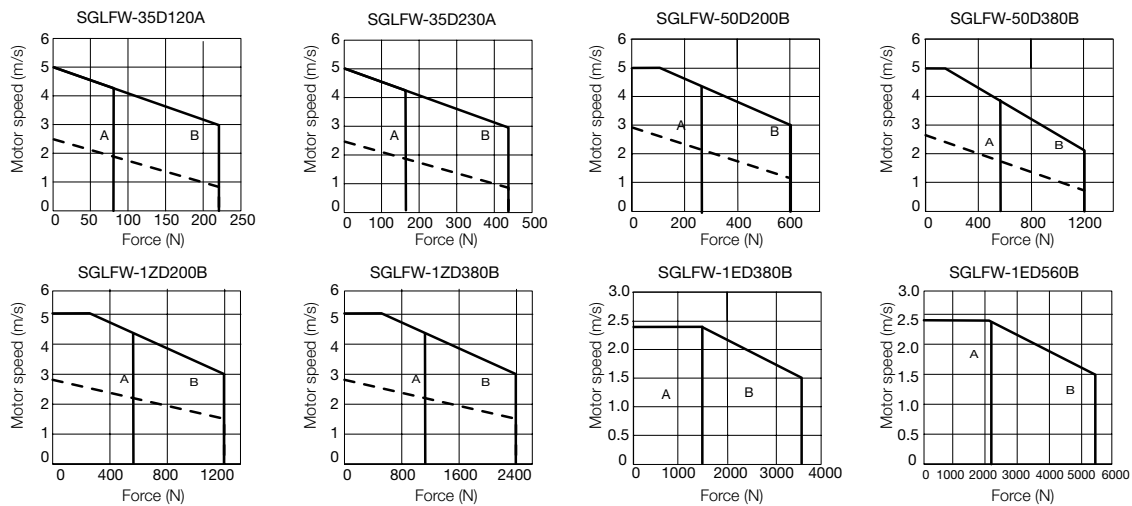

Note:
 The dotted line indicates characteristics when the Linear Motor for 400 VAC is used with an input power supply for 230 VAC. In this case, the serial converter should be changed. Contact your sales representatives.

Dimensions for iron-core SGLFW/SGLFM models

Coil assembly: SGLFW-□□□□□□□□

Coil assembly model SGLFW-	Width [mm]	Height [mm]	Length [mm]		Total, L	Weight* [kg]
	incl. Magnetic Way, W	incl. Magnetic Way, H	Moving Coil, L1	Polarity Sensor, A		
20A090A□	44	32	91	30	121	0.7
20A120A□			127		157	0.9
35o120A□			127		157	1.3
35o230A□	60	40	235	70	265	2.3
50o200B□	215		245		3.5	
50o380B□	395		425		6.9	
1Zo200B□	125	40	215	70	245	6.4
1Zo380B□			395		425	11.5
1ED380B□	200	76	390	70	460	20
1ED560B□			600		670	29

* The values indicate the mass of a moving coil with a polarity sensor.

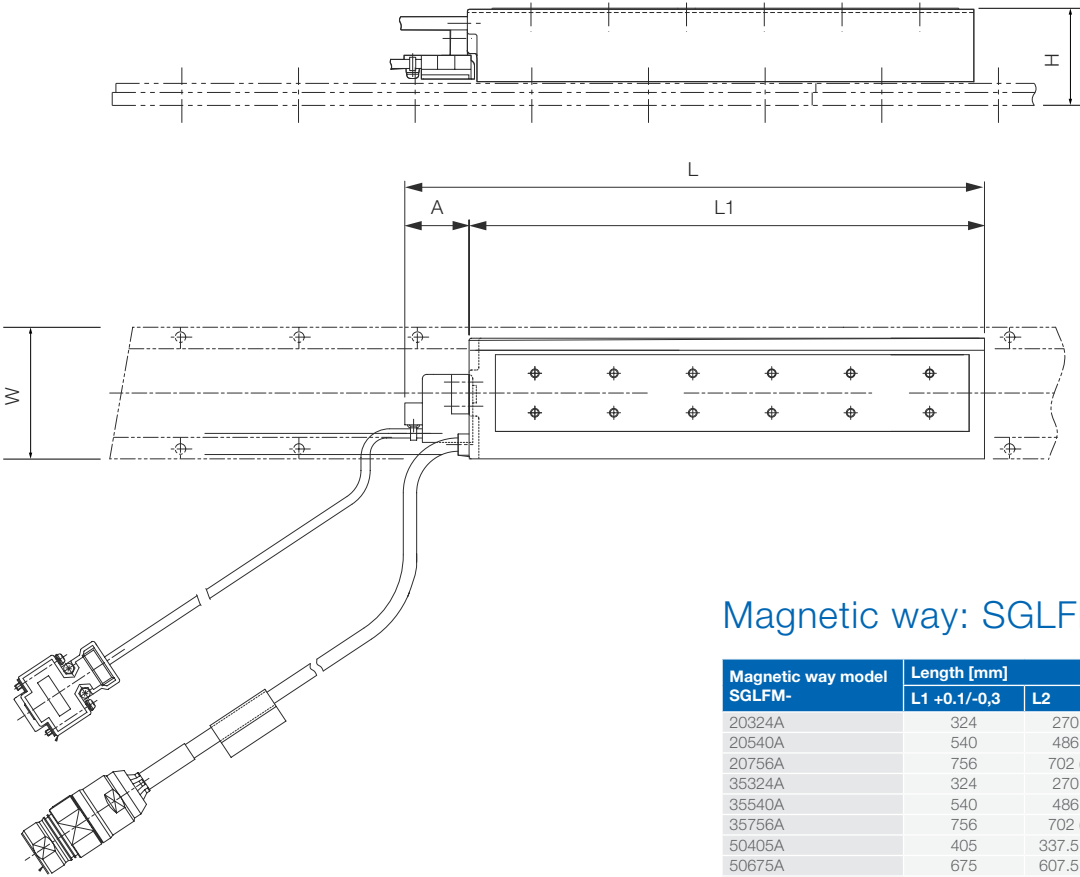

Magnetic way: SGLFM-□□□□□A

Magnetic way model SGLFM-	Length [mm]		Weight [kg]
	L1 +0.1/-0.3	L2	
20324A	324	270 (54 × 5)	0.9
20540A	540	486 (54 × 9)	1.4
20756A	756	702 (54 × 13)	2
35324A	324	270 (54 × 5)	1.2
35540A	540	486 (54 × 9)	2
35756A	756	702 (54 × 13)	2.9
50405A	405	337.5 (67.5 × 5)	2.8
50675A	675	607.5 (67.5 × 9)	4.6
50945A	945	877.5 (67.5 × 13)	6.5
12405A	405	337.5 (67.5 × 5)	5
12675A	675	607.5 (67.5 × 9)	8.3
12945A	945	877.5 (67.5 × 13)	12
1E135A	135	67.5	2.5

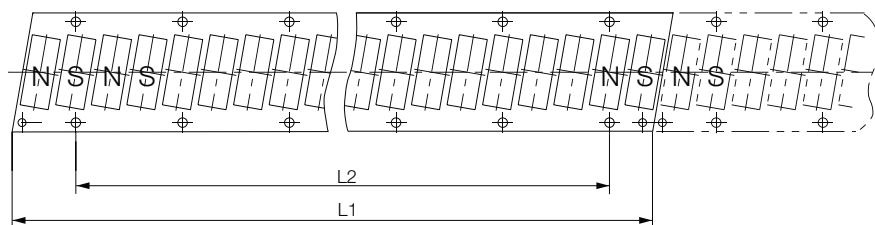

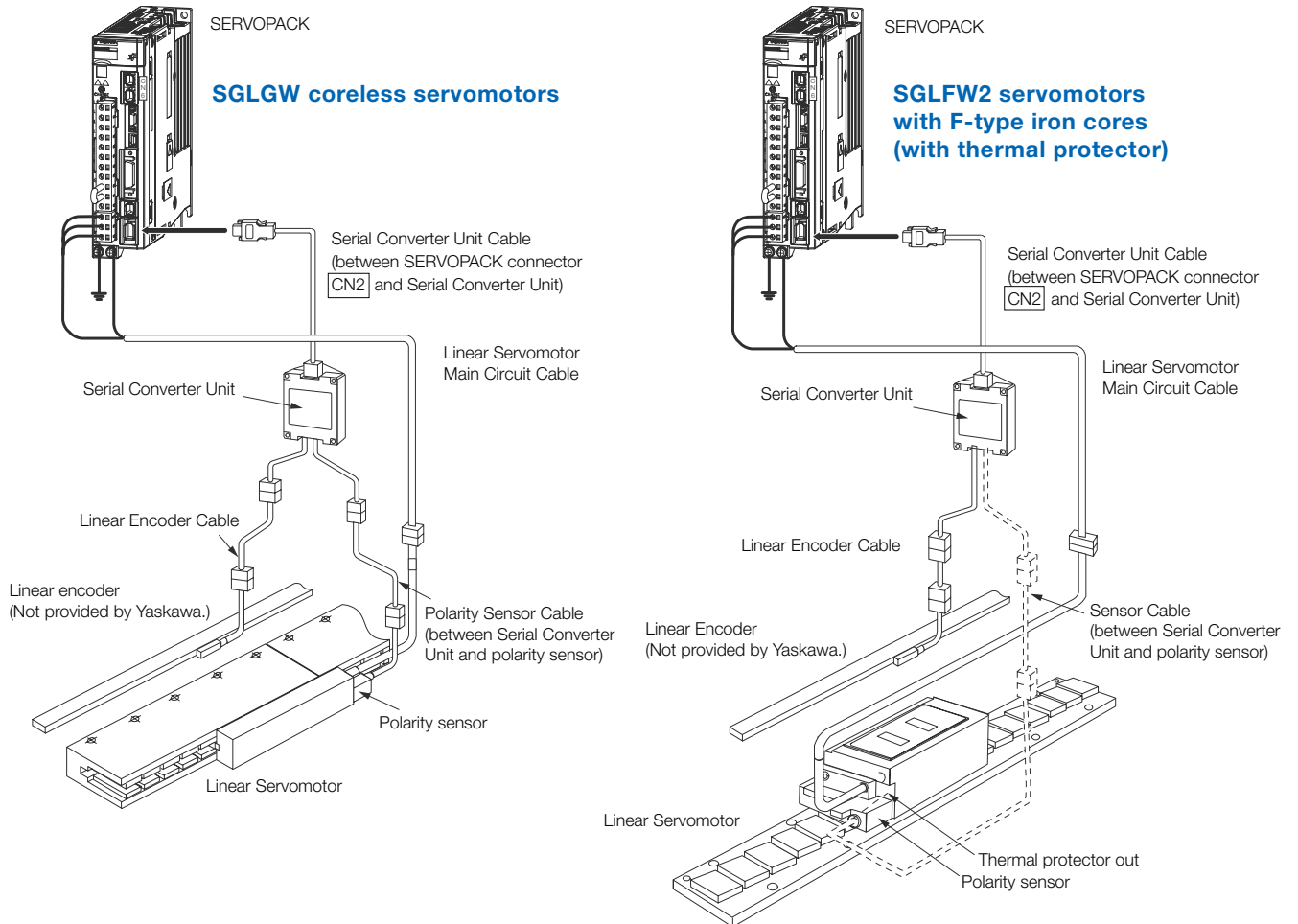

System configurations



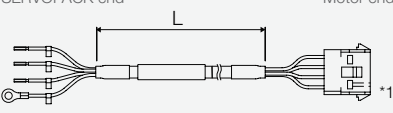
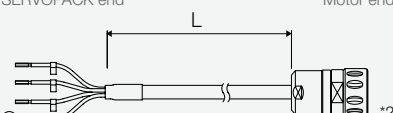
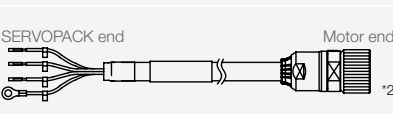
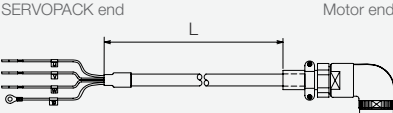

Cable selection

Linear motor power cables

Servomotor model	Order no.	Appearance
SGLGW SGLFW -30A, -40A, -60A -20A, -35A	JZSP-CLN11-□□-E	SERVOPACK end Motor end 
SGLGW SGLFW -90A -50A, -1ZA	JZSP-CLN21-□□-E	SERVOPACK end Motor end 
SGLGW to -30A□□□□□□ -60A□□□□□□	DP9325252-□□G	SERVOPACK end Motor end 
SGLFW to -35A□□□□□□ -1ZA□□□□□□	DP9325254-□□G	SERVOPACK end Motor end 
SGLFW -35D□□□□□□ -50D200□□□	JZSP-CMM20D15-□□G	SERVOPACK end Motor end 
SGLFW -50D380□□□ -1ZD□□□□□□	JZSP-CLN15-□□-E-G#	SERVOPACK end Motor end
SGLFW -1ED□□□□□□	JZSP-CVMCA13-□□-E-G#	SERVOPACK end Motor end

Cable selection

Linear motor power cables (cont'd.)

Servomotor model	Order no.	Appearance
SGLFW2 -30A070 to -30A230	JZSP-C7M143-□□-E-G6	
SGLFW2 -45A200	JZSP-C7M144-□□-E-G6	
SGLFW2 -45A380 to -90A200	JZSP-C7M154-□□-E-G6	
SGLFW2 -90A380 to -90A560	JZSP-C7M164-□□-E-G6	
SGLFW2 -30D070 to -45D380	JZSP-C7M143-□□-E-G6	
SGLFW2 -90D200 to -1DD380	JZSP-C7M154-□□-E-G6	
SGLFW2 -1DD560	JZSP-C7M164-□□-E-G6	

Linear encoder cables

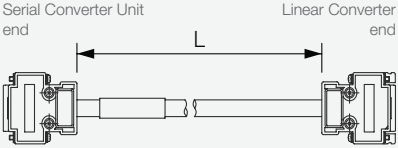
Servomotor model	Order no.	Name	Appearance
All models	JZSP-CLL00-□□-E-G#	For linear encoder from Renishaw PLC	
	JZSP-CLL30-□□-E	For linear encoder from Heidenhain Corporation	

Serial converter unit cables

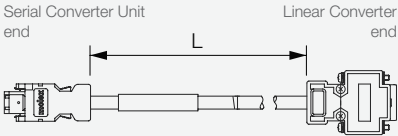
Servomotor model	Order no.	Appearance
All models	JZSP-CLP70-□□-E-G#	

Sensor cables

Servomotor model	Order no.	Appearance
SGLGW-□□A SGLFW-□□A SGLFW-□□D	JZSP-CLL10-□□-E-G#	
SGLFW2-□□A□□□AS□ (With Polarity Sensor)	JZSP-CL2L100-□□-E	
SGLFW2-□□A□□□AT□ (Without Polarity Sensor)	JZSP-CL2TH00-□□-E	

Notes:

The digits "□□" of the order number represent the cable length (1, 3, 5, 10, 15, 20 meters).

Estimates are available for models other than those listed above (SGLFW2-90A□□□□A□L and SGLFW2-1D□□□□A□L).

- *1. Connector from TycoElectronics Japan G.K.
- *2. Connector from Interconnectron GmbH

When using a JZDP-J00□-□□□-E Serial Converter Unit, do not exceed a cable length of 3 m.

The digit „#“ of the order number represents the design revision.

Serial converter specifications

Model designations

JZDP - $\square\square\square\square$ $\square\square\square$ - E
1st ... 4th 5th ... 7th 8th + 9th digit

For Sigma-7 Servo Drives

1st ... 4th digit - Serial converter unit model				
Code	Appearance	Applicable linear encoder	Polarity sensor	Thermal protector
H003 J003		From Heidenhain Corp.	None	None
H005 J005		From Renishaw PLC	None	None
H006 J006		From Heidenhain Corp.	Yes	Yes
H008 J008		From Renishaw PLC	Yes	Yes

For Sigma-5 Servo Drives

1st ... 4th digit - Serial Converter Unit Model			
Code	Appearance	Applicable linear encoder	Hall sensor
D003 G003		From Heidenhain Corp.	None
D005 G005		From Renishaw PLC	None
D006 G006		From Heidenhain Corp.	Yes
D008 G008		From Renishaw PLC	Yes

5th ... 7th digit - Applicable linear servomotor						
Servomotor model		Code	Servomotor model		Code	
SGLGW (Coreless models) with Standard-force Magnetic way	200 V	30A050C	250	SGLFW2 (Models with F-type Iron Cores)	30A070A	628
		30A080C	251		30A120A	629
		40A140C	252		30A230A	630
		40A253C	253		45A200A	631
		40A365C	254		45A380A	632
		60A140C	258		90A200A	633
		60A253C	259		90A380A	634
		60A365C	260		90A560A	648
		90A200C	264		1DA380A	649
		90A370C	265		1DA560A	650
SGLGW- + SGLGM-o-M (Coreless models) with High-force Magnetic way	200 V	40A140C	255	30D070A	651	
		40A253C	256	30D120A	652	
		40A365C	257	30D230A	653	
		60A140C	261	45D200A	654	
		60A253C	262	45D380A	655	
		60A365C	263	90D200A	657	
SGLFW (Models with F-type Iron Cores)	200 V	20A090A	017	400 V	90D380A	658
		20A120A	018		90D560A	659
		35A120A	019		1DD380A	660
		35A230A	020		1DD560A	661
		50A200B	181			
		50A380B	182			
		1ZA200B	183			
	400 V	1ZA380B	184			
		35D120A	211			
		35D230A	212			
		50D200B	189			
		50D380B	190			
		1ZD200B	191			
		1ZD380B	192			
1ED380B	333					
1ED560B	334					

8th + 9th digit - Model code extension	
Code	Specification
	For Sigma-7 servomotors
-E	Serial converter units for Sigma-5 servo drives

Notes:

- Code H000 for 8 bit interpolation, Code J000 for 12 bit interpolation.
- Refer to the catalog for detailed specifications of the Serial Converter Unit.
- Contact your YASKAWA representative for information on the water cooling specifications of the SGLFW2.

YASKAWA Europe GmbH

Drives Motion Controls Division
Hauptstr. 185
65760 Eschborn
Germany

+49 6196 569-500
support@yaskawa.eu.com
www.yaskawa.eu.com

Specifications are subject to change without notice for ongoing product modifications and improvements. © YASKAWA Europe GmbH. All rights reserved. Printed on FSC®-certified paper from responsible sources.

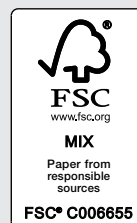

11/2017
YEU_LinearMotors_EN_v6

YASKAWA