

YASKAWA

MOTOMAN GP20HL

Handling & General Applications
with the GP-series

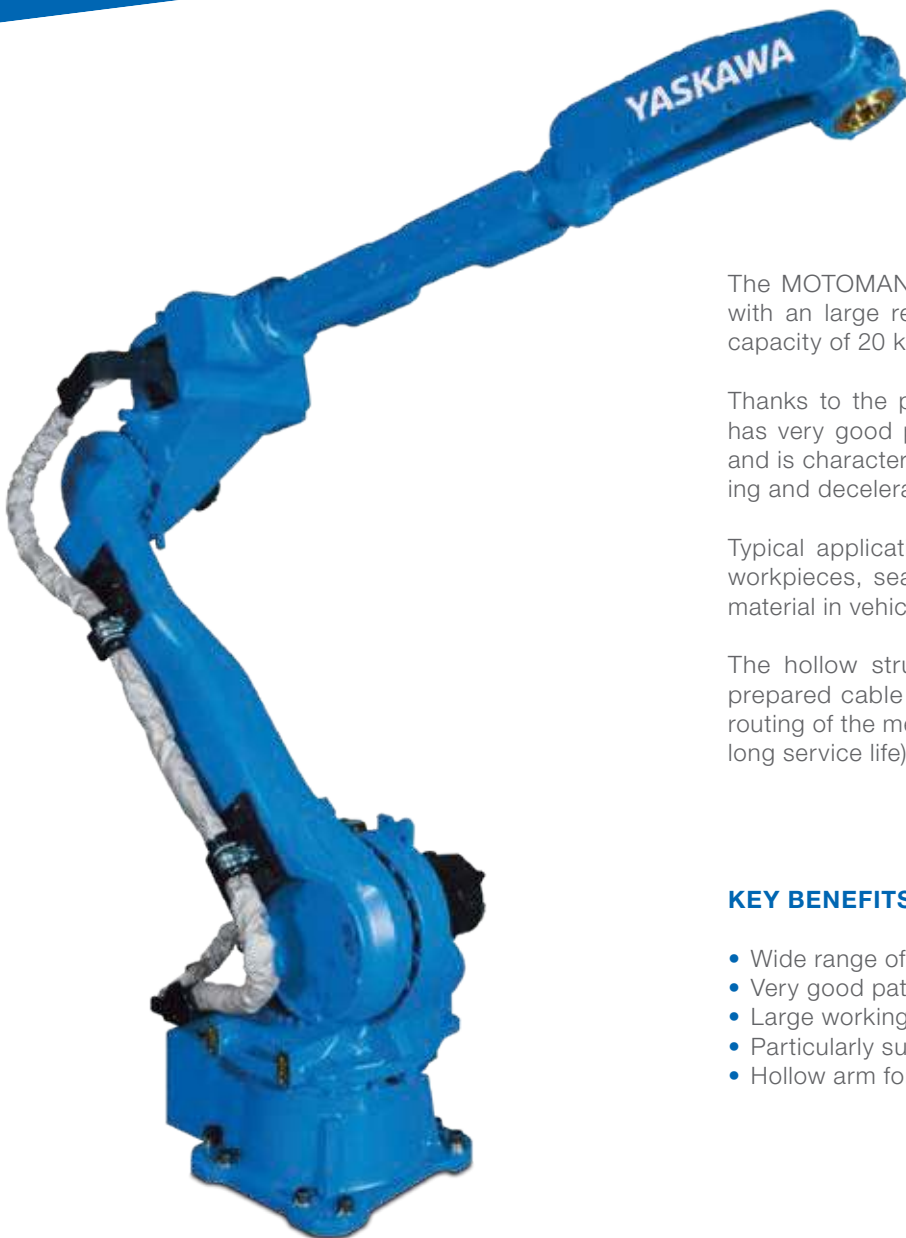

The MOTOMAN GP20HL is a universally deployable robot with an large reach of 3,124 mm and a maximum payload capacity of 20 kg.

Thanks to the patented vibration control system, this robot has very good positioning accuracy and path performance, and is characterized by almost no oscillation when accelerating and decelerating in the fully extended position.

Typical applications for this robot is handling of very large workpieces, seam sealing, and the application of insulating material in vehicle body production.

The hollow structure of the wrist joint and a number of prepared cable and hose guides in the arm enable optimal routing of the media supply lines (high freedom of motion and long service life).

KEY BENEFITS

- Wide range of potential applications
- Very good path performance
- Large working range: 3,124 mm
- Particularly suitable for large and bulky workpieces
- Hollow arm for optimal media supply

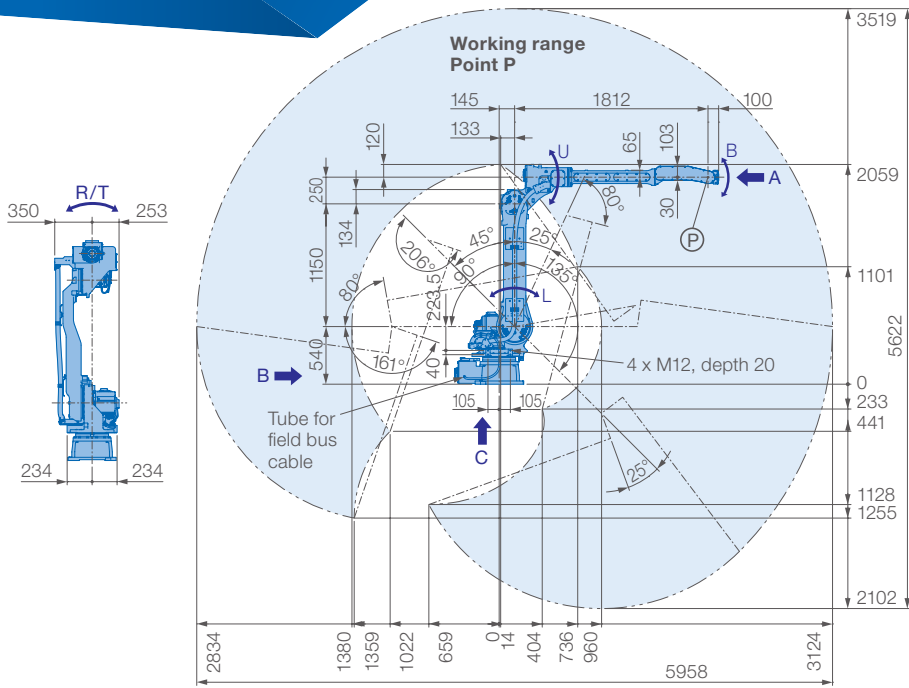

View A

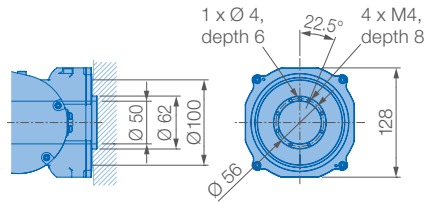

View B

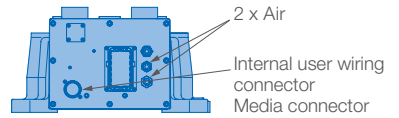

View C

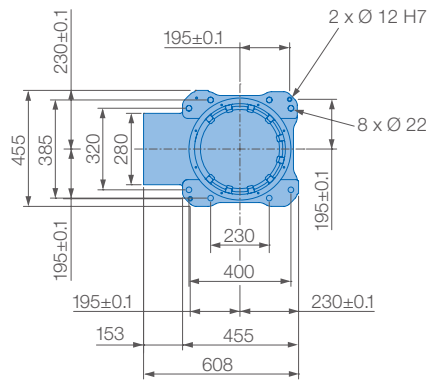

Mounting options: Floor, ceiling, wall, tilt*

Protection class: IP54/IP67

* tilt with condition of angle – see table below

Robot installation angle θ [deg.]	S-axis operating range [deg.]
$0 \leq \theta \leq 30$	± 180 degrees or less (no limit)
$30 < \theta \leq 35$	± 60 degrees or less
$35 < \theta \leq 45$	± 45 degrees or less
$45 < \theta$	± 30 degrees or less



Prevent interaction of the robot with:

- Corrosive gases, liquids or explosive gases
- Exposure to water, oil or dust
- Excessive electrical noise (plasma)

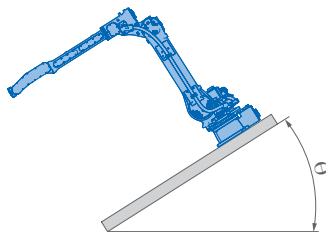

Allowable wrist load

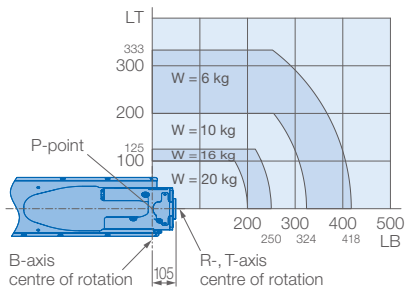

Specifications GP20HL						
Axes	Maximum motion range [°]	Maximum speed [°/sec.]	Allowable moment [Nm]	Allowable moment of inertia [kg · m ²]	Controlled axes	6
S	± 180	180	–	–	Max. payload [kg]	20
L	$+135/-90$	180	–	–	Repeatability [mm]	± 0.07
U	$+206/-80$	180	–	–	Max. working range R [mm]	3124
R	± 200	400	39.2	1.05	Temperature [°C]	0 to +45
B	± 150	430	39.2	1.05	Humidity [%]	20 – 80
T	± 455	630	19.6	0.75	Weight [kg]	560
					Power supply, average [KVA]	4.0

Yaskawa Europe GmbH

Robotics Division
Yaskawastraße 1
85391 Allershausen
Germany

Tel. +49 (0) 8166 90-0
robotics@yaskawa.eu.com
www.yaskawa.eu.com

YR-1-06VXHL20-A00
B-10-2020, A-No. 195934